

General Description

The evaluation test board has one RMSW220D™ SPDT RF switch : a SPDT switch, with SMA RF connectors. The evaluation test board will need to be operated from a DC supply voltage .

- External DC ground return is required at all RF ports.

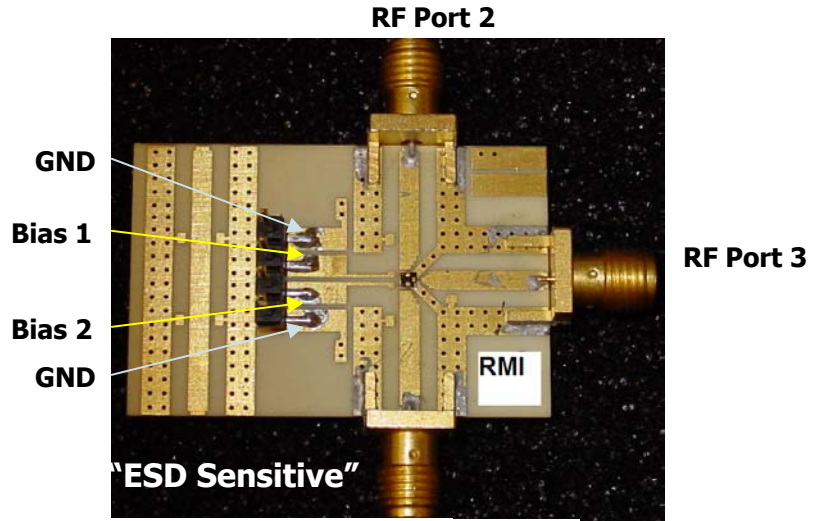

CH1: S11 FWD REFL
LOG MAGNITUDE
REF= 0.000 dB
10.000 dB/DIV

CH3: S21 FWD TRANS
LOG MAGNITUDE
REF= 0.000 dB
0.200 dB/DIV

CH 3 - S21 RF Port 1
REFERENCE PLANE
0.0000 mm

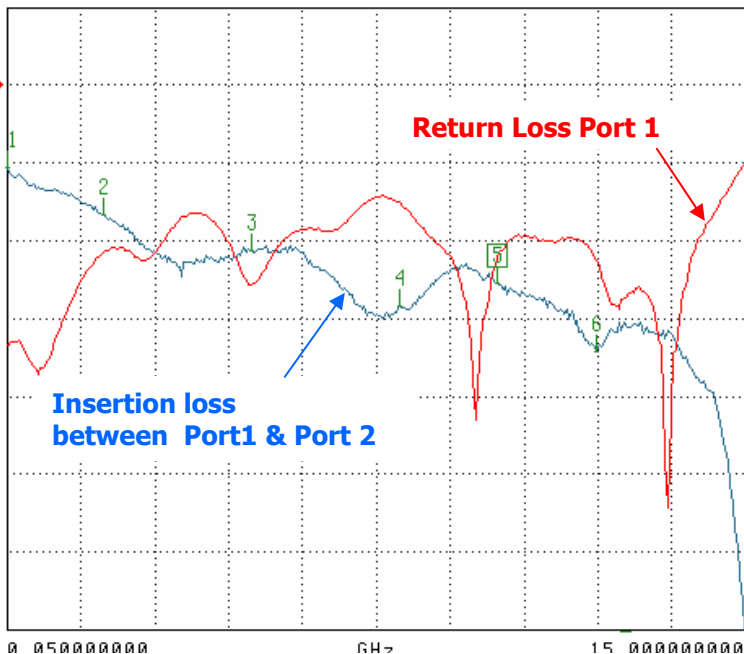

MARKER 5
10.000000000 GHz
-0.508 dB

MARKER TO MAX
MARKER TO MIN

1	0.050000000 GHz	-0.214 dB
2	2.000000000 GHz	-0.332 dB
3	5.000000000 GHz	-0.426 dB
4	8.000000000 GHz	-0.571 dB
6	12.000000000 GHz	-0.687 dB

MARKER READOUT
FUNCTIONS

Insertion Loss (Test Board minus Reference Line Loss)

Bias 1	Bias 2	RF Port 2	RF Port 3
- 100 V	0 V	ON	OFF
0 V	-100 V	OFF	ON

"RMSW220D-EV12™" Evaluation Test Board

CH1: S11 FWD REFL
LOG MAGNITUDE
REF=0.000 dB
10.000 dB/DIV

CH3: S21 FWD TRANS
LOG MAGNITUDE
REF=0.000 dB
0.200 dB/DIV

CH 3 - S21
REFERENCE PLANE
0.0000 mm

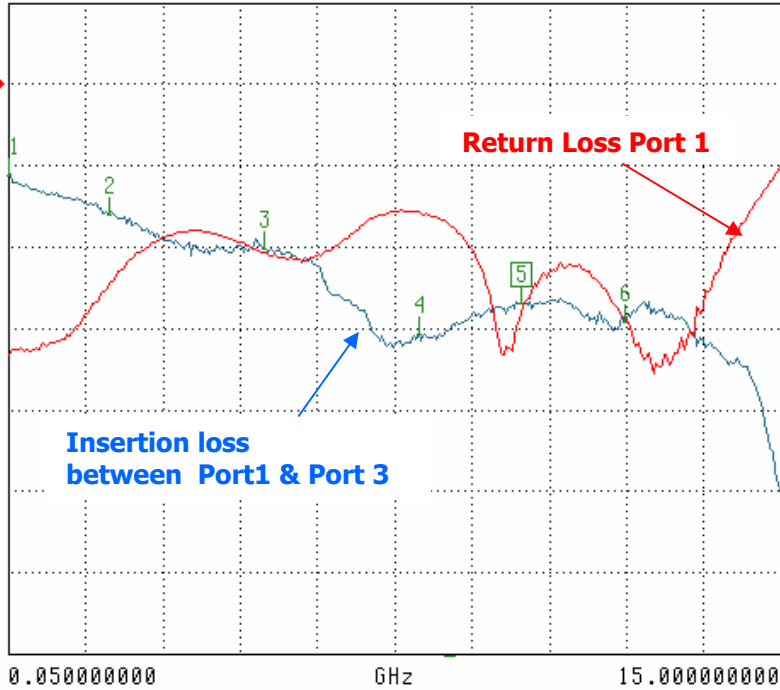

MARKER 5
10.000000000 GHz
-0.538 dB

MARKER TO MAX
MARKER TO MIN

- 1 0.050000000 GHz
-0.225 dB
- 2 2.000000000 GHz
-0.321 dB
- 3 5.000000000 GHz
-0.407 dB
- 4 8.000000000 GHz
-0.615 dB
- 6 12.000000000 GHz
-0.585 dB

MARKER READOUT
FUNCTIONS

Insertion Loss , (Test Board minus Reference Line Loss)

CH1: S11 FWD REFL
LOG MAGNITUDE
REF=0.000 dB
10.000 dB/DIV

CH3: S21 FWD TRANS
LOG MAGNITUDE
REF=0.000 dB
10.000 dB/DIV

CH 3 - S21
REFERENCE PLANE
0.0000 mm

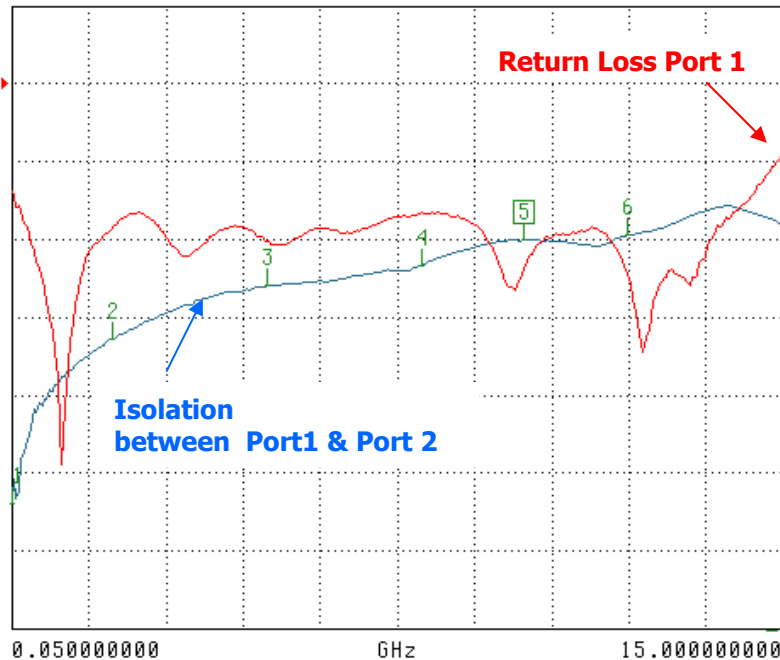

MARKER 5
10.000000000 GHz
-20.098 dB

MARKER TO MAX
MARKER TO MIN

- 1 0.050000000 GHz
-54.018 dB
- 2 2.000000000 GHz
-32.883 dB
- 3 5.000000000 GHz
-25.962 dB
- 4 8.000000000 GHz
-23.320 dB
- 6 12.000000000 GHz
-19.443 dB

MARKER READOUT
FUNCTIONS

Isolation

■ Phone: 978-

"RMSW220D-EV12™" Evaluation Test Board

CH1: S11 FWD REFL
LOG MAGNITUDE
REF=0.000 dB
10.000 dB/DIV

CH3: S21 FWD TRANS
LOG MAGNITUDE
REF=0.000 dB
10.000 dB/DIV

CH 3 - S21
REFERENCE PLANE
0.0000 mm

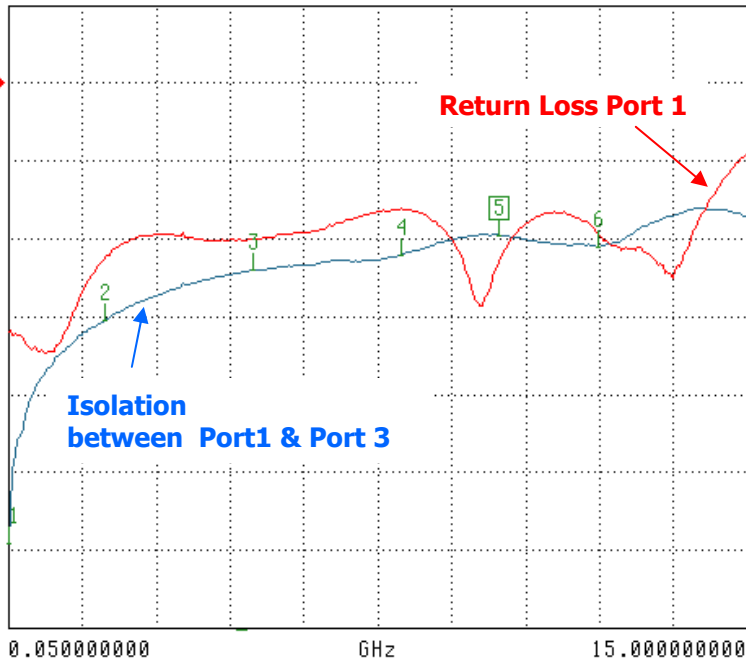

MARKER 5
10.000000000 GHz
-19.585 dB

MARKER TO MAX
MARKER TO MIN

- 1 0.050000000 GHz
-59.138 dB
- 2 2.000000000 GHz
-30.440 dB
- 3 5.000000000 GHz
-24.097 dB
- 4 8.000000000 GHz
-22.111 dB
- 6 12.000000000 GHz
-21.025 dB

MARKER READOUT
FUNCTIONS

Isolation

CH1: S11 FWD REFL
LOG MAGNITUDE
REF=0.000 dB
10.000 dB/DIV

CH3: S21 FWD TRANS
LOG MAGNITUDE
REF=0.000 dB
0.200 dB/DIV

CH 3 - S21
REFERENCE PLANE
0.0000 mm

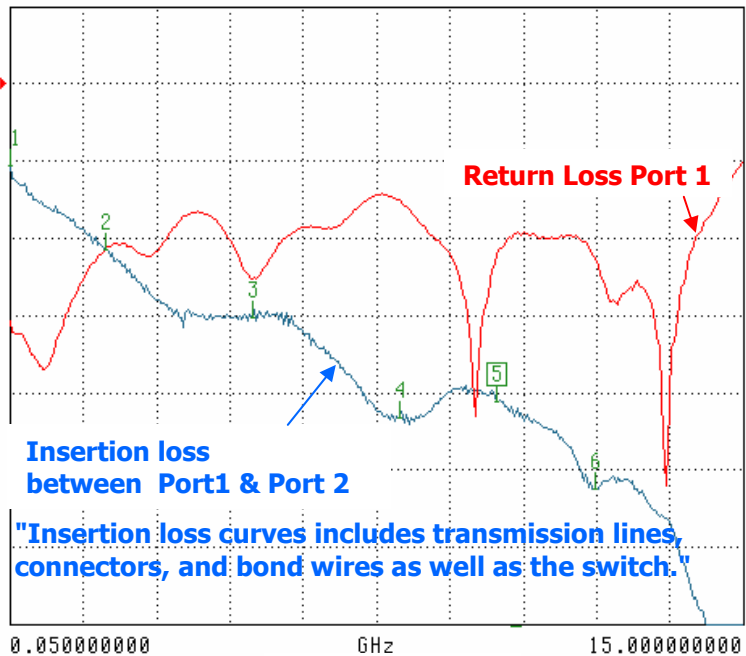

MARKER 5
10.000000000 GHz
-0.824 dB

MARKER TO MAX
MARKER TO MIN

- 1 0.050000000 GHz
-0.212 dB
- 2 2.000000000 GHz
-0.431 dB
- 3 5.000000000 GHz
-0.606 dB
- 4 8.000000000 GHz
-0.867 dB
- 6 12.000000000 GHz
-1.051 dB

MARKER READOUT
FUNCTIONS

Insertion loss

RADANT MEMS INC.

- Phone: 978-562-3866
- Fax: 978-562-6277
- Email: sales@radantmems.com
- Visit www.radantmems.com

"RMSW220D-EV12™" Evaluation Test Board

CH1: S11 FWD REFL
LOG MAGNITUDE
REF=0.000 dB
10.000 dB/DIV

CH3: S21 FWD TRANS
LOG MAGNITUDE
REF=0.000 dB
0.200 dB/DIV

CH 3 - S21
REFERENCE PLANE
0.0000 mm

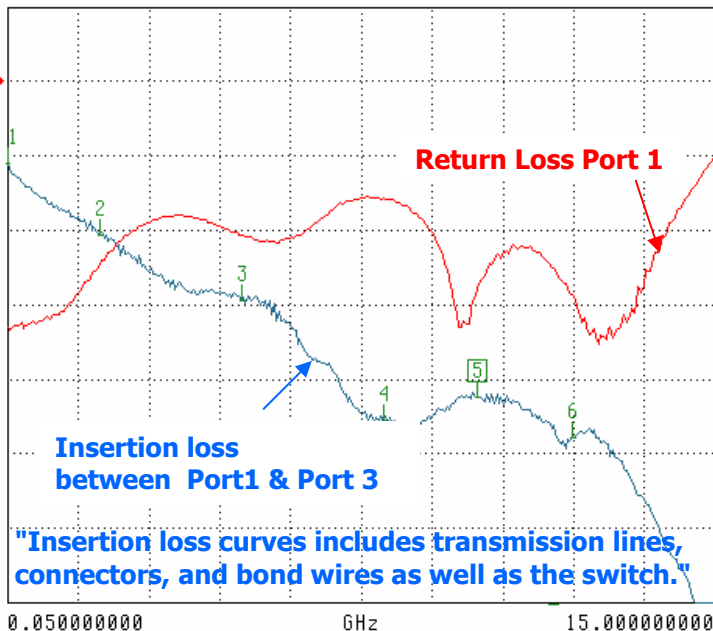

MARKER 5
10.000000000 GHz
-0.849 dB

MARKER TO MAX
MARKER TO MIN

- | | | |
|---|------------------|-----------|
| 1 | 0.050000000 GHz | -0.220 dB |
| 2 | 2.000000000 GHz | -0.412 dB |
| 3 | 5.000000000 GHz | -0.590 dB |
| 4 | 8.000000000 GHz | -0.914 dB |
| 6 | 12.000000000 GHz | -0.958 dB |

MARKER READOUT
FUNCTIONS

Insertion loss

CH1: S22 REV REFL
LOG MAGNITUDE
REF=0.000 dB
10.000 dB/DIV

CH3: S21 FWD TRANS
LOG MAGNITUDE
REF=0.000 dB
0.500 dB/DIV

CH 3 - S21
REFERENCE PLANE
0.0000 mm

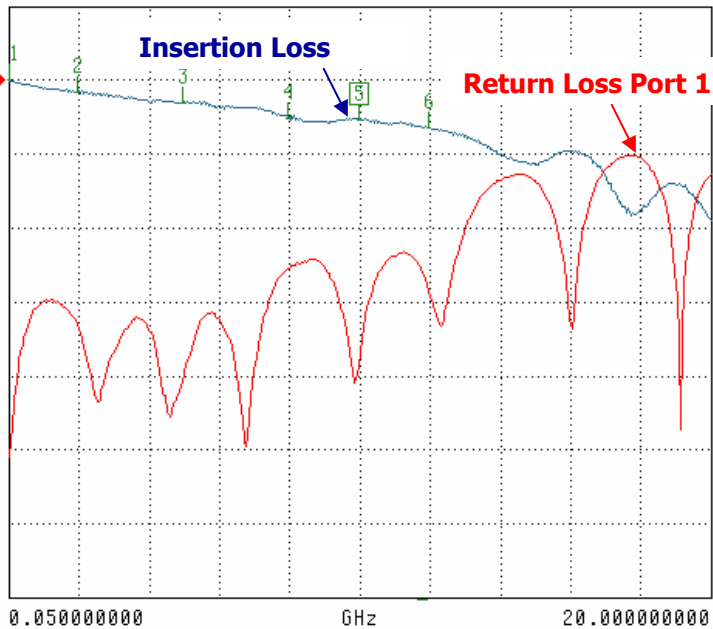

MARKER 5
10.000000000 GHz
-0.300 dB

MARKER TO MAX
MARKER TO MIN

- | | | |
|---|------------------|-----------|
| 1 | 0.050000000 GHz | 0.003 dB |
| 2 | 2.000000000 GHz | -0.095 dB |
| 3 | 5.000000000 GHz | -0.170 dB |
| 4 | 8.000000000 GHz | -0.296 dB |
| 6 | 12.000000000 GHz | -0.372 dB |

MARKER READOUT
FUNCTIONS

Reference Line (Insertion Loss and Return Loss)